

### Description

- Simple package crystal oscillator (SPXO) in a seam sealed ceramic package with a metal lid and operates over a wide supply voltage range of 1.62V to 3.63V  
Wide operating temperature range (-40°C TO 125°C) for industrial applications, not for Automotive.
- Model IQXO-951 3225
- Model Issue number 3

### Frequency Parameters

- Frequency 12.0MHz
- Frequency Stability  $\pm 50.00$ ppm
- Operating Temperature Range -40.00 to 105.00°C
- Ageing  $\pm 3$ ppm max in 1st year @ 25°C
- Frequency Stability: inclusive of frequency tolerance at 25°C  $\pm 3^\circ\text{C}$  and over the operating temperature range.

### Electrical Parameters

- Current Draw (no load) 7.000mA max
- Supply Voltage: 1.62V min to 3.63V max

### Output Details

- Output Compatibility CMOS
- Drive Capability 15pF max
- Rise and Fall Time 7.0ns max
- Duty Cycle 45/55% max

### Output Control

- Standby Operation:  
Logic '1' (>70% VS) to pad 1 enables oscillator output  
Logic '0' (<30% VS) to pad 1 disables oscillator output; when disabled the oscillator output goes to the high impedance state  
No connection to pad 1 enables oscillator output.
- Start-up Time: 10ms max  
0.2ms typ to 90% of final amplitude (under ideal conditions @ 25°C)
- Standby Current:  
1.5 $\mu\text{A}$  typ @ 25°C  
10 $\mu\text{A}$  max over operating temp range -40 to 85°C  
20 $\mu\text{A}$  max over operating temp range 85 to 125°C

### Output Levels

- Output Voltage Levels:  
Output High (VoH): Vs-0.4V min  
Output Low (VoL): 0.4V max

### Noise Parameters

- RMS Phase Jitter (12kHz to 20MHz): 365fs typ @ 25MHz
- Phase Noise (typ @ 25MHz and @ 25°C):  
-89dBc/Hz @ 10Hz  
-118dBc/Hz @ 100Hz  
-135dBc/Hz @ 1kHz  
-143dBc/Hz @ 10kHz  
-151dBc/Hz @ 100kHz  
-154dBc/Hz @ 1MHz  
-155dBc/Hz @ 5MHz

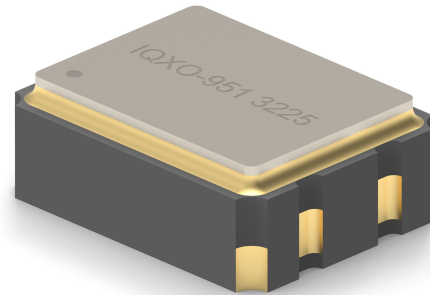

### Outline (mm)

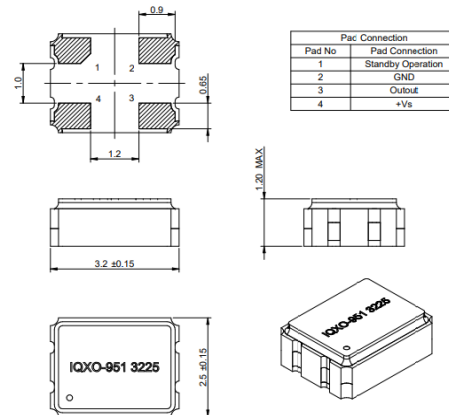

### Recommended Solder Pad Layout

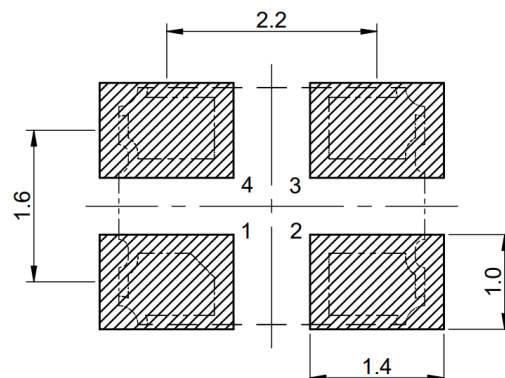

### CONTACT INFORMATION:

Würth Elektronik eiSos GmbH & Co. KG  
Max-Eyth-Str. 1, 74638 Waldenburg, Germany  
Tel: +49(0) 7942 945-0

Email: eiSos@we-online.de  
Web: www.we-online.com

### Environmental Parameters

- Storage Temperature Range: -55 to 125°C
- Vibration (MIL-STD-883F:2007.3): 20Hz~2000Hz, 1.52mm peak amplitude, 20g acceleration in 3 mutually perpendicular planes, sweep time 20 minutes per axis (total 4 hours)
- Shock (MIL-STD-883F:2002.4.Condition B): Half-sine shock pulse peak acceleration of 1500g, pulse duration of 0.5ms.

### Manufacturing Details

- RoHS Terminations Au
- RoHS Reflow Temp 260°C max

### Compliance

- RoHS Status (2015/863/EU) Compliant
- REACH Status Compliant
- MSL Rating (JDEC-STD-033): 1

### Packaging Details

- Tape & reel in accordance with EIA-481  
Quantities below the standard reel size to be supplied on cut tape.  
Standard Quantity: 3,000 Pieces
- 

## USEFUL LINKS

#### Toolbox:

[www.we-online.com/toolbox](http://www.we-online.com/toolbox)

#### Product Catalog:

[www.we-online.com/products](http://www.we-online.com/products)

### CONTACT INFORMATION:

Würth Elektronik eiSos GmbH & Co. KG  
Max-Eyth-Str. 1, 74638 Waldenburg, Germany  
Tel: +49(0) 7942 945-0

Email: [eiSos@we-online.de](mailto:eiSos@we-online.de)  
Web: [www.we-online.com](http://www.we-online.com)