

Description

- Simple package crystal oscillator (SPXO) in a seam sealed ceramic package with a metal lid and operates over a wide supply voltage range of 1.62V to 3.63V
- Model IQXO-951 2016
- Model Issue number 3
- Note: Operating temperature range -40 to 125°C is intended for industrial use and not for safety critical applications such as automotive. Please contact IQD for alternative options.

Frequency Parameters

- Frequency 8.0MHz
- Frequency Stability ± 50.00 ppm
- Operating Temperature Range -40.00 to 105.00°C
- Ageing ± 3 ppm max in 1st year @ 25°C
- Frequency Stability: inclusive of frequency tolerance at 25°C $\pm 3^\circ\text{C}$ and over the operating temperature range.

Electrical Parameters

- Current Draw (no load) 5.000mA max
- Supply Voltage: 1.62V min to 3.63V max

Output Details

- Output Compatibility CMOS
- Drive Capability 15pF max
- Rise and Fall Time 6.0ns max
- Duty Cycle 45/55% max

Output Control

- Standby Operation:
Logic '1' (>70% VS) to pad 1 enables oscillator output
Logic '0' (<30% VS) to pad 1 disables oscillator output; when disabled the oscillator output goes to the high impedance state
No connection to pad 1 enables oscillator output.
- Start-up Time: 10ms max
0.3ms typ to 90% of final amplitude (under ideal conditions @ 25°C)
- Standby Current:
1.5 μA typ @ 25°C
10 μA max over operating temp range -40 to 85°C
20 μA max over operating temp range 85 to 125°C

Output Levels

- Output Voltage Levels:
Output High (VoH): Vs-0.4V min
Output Low (VoL): 0.4V max

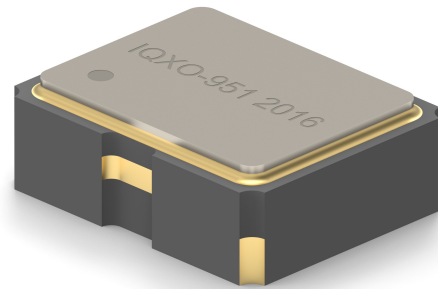

Outline (mm)

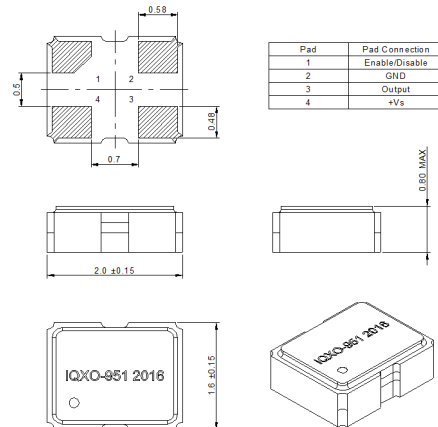

Recommended Solder Pad Layout

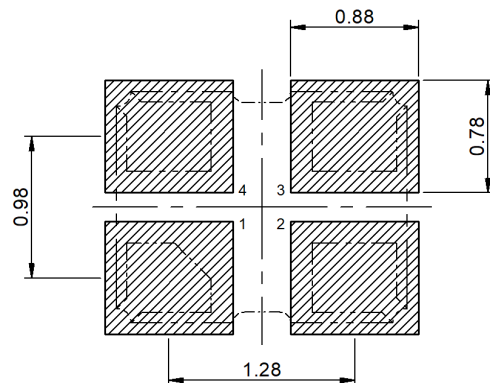

CONTACT INFORMATION:

Würth Elektronik eiSos GmbH & Co. KG
Max-Eyth-Str. 1, 74638 Waldenburg, Germany
Tel: +49(0) 7942 945-0

Email: eiSos@we-online.de
Web: www.we-online.com

Noise Parameters

- RMS Phase Jitter (12kHz to 20MHz): 368fs typ @ 25MHz
- Phase Noise (typ @ 25MHz and @ 25°C):
 - 90dBc/Hz @ 10Hz
 - 118dBc/Hz @ 100Hz
 - 132dBc/Hz @ 1kHz
 - 145dBc/Hz @ 10kHz
 - 151dBc/Hz @ 100kHz
 - 154dBc/Hz @ 1MHz
 - 155dBc/Hz @ 5MHz

Environmental Parameters

- Storage Temperature Range: -55 to 125°C
- Shock (MIL-STD-883F:2002.4.Condition B): Half-sine shock pulse peak acceleration of 1500g, pulse duration of 0.5ms.
- Vibration (MIL-STD-883F:2007.3): 20Hz~2000Hz, 1.52mm peak amplitude, 20g acceleration in 3 mutually perpendicular planes, sweep time 20 minutes per axis (total 4 hours)

Manufacturing Details

- RoHS Terminations Au
- RoHS Reflow Temp 260°C max

Compliance

- RoHS Status (2015/863/EU) Compliant
- REACH Status Compliant
- MSL Rating (JDEC-STD-033): 1

Packaging Details

- Tape & reel in accordance with EIA-481
Quantities below the standard reel size to be supplied on cut tape.
Standard Quantity: 3,000 Pieces

■

USEFUL LINKS

Toolbox:

www.we-online.com/toolbox

Product Catalog:

www.we-online.com/products

CONTACT INFORMATION:

Würth Elektronik eiSos GmbH & Co. KG
Max-Eyth-Str. 1, 74638 Waldenburg, Germany
Tel: +49(0) 7942 945-0

Email: eiSos@we-online.de
Web: www.we-online.com